

**CD-D11U**  
**1x1 CD Duplicator**  
*with USB Output*  
**User's Manual**



**TASCAM** 



---

## Safety Precautions

TASCAM CD Duplicator systems are high precision electronic devices. Do not use them in any manner other than as specified in this manual. Please read this manual in its entirety before you begin the installation procedure. Use of controls, adjustments, or performance of procedures other than those specified herein may result in hazardous radiation exposure.

To prevent fire or shock, do not expose the unit to moisture or rain.

To prevent electrical shock, do not attempt to disassemble the CD Duplicator system. Refer servicing to authorized personnel.

The CD Duplicator drives utilize a laser beam that can be harmful to your eyes. Do not disassemble the cabinet or unit. Do not attempt to look through the front panel or into the unit while the power is turned on.

A user who changes or modifies the unit or operating procedures specified herein without express written approval by the manufacturer will void user authority to operate the equipment.

Specifications and features subject to change without notice or obligation.

---

## FCC Radio Frequency Interference Regulations

**Warning:** This equipment generates, uses, and can radiate radio frequency energy and if not installed and used in accordance with the instructions contained in this manual, may cause harmful interference to radio and television communications. This equipment has been tested and found to comply with the limits for a Class B digital device pursuant to Subpart J of Part 15 of the FCC Rules. These limits are designed to provide reasonable protection against harmful interference in a residential installation. However, there is no guarantee that interference will not occur in a particular installation. To ensure compliance with FCC rules, the cable that connects the unit to the computer must be a shielded interface cable.

**Note:** Connecting this device to peripheral devices that do not comply with Class B requirements or using an unshielded peripheral cable could result in interference to radio or television reception. To ensure that the use of this product does not contribute to interference, use a shielded interface cable.

If this equipment does cause harmful interference to radio or television reception (which can be determined by turning the equipment off and on), the user may try to correct the interference by one or more of the following measures:

- Reorient or relocate the receiving antenna.
- Move the device and the receiver further apart.
- Connect the equipment to an electrical outlet on a different circuit than the receiver.
- Consult the dealer or an experienced audio television technician.

Also, the following booklet may prove helpful: *How to Identify and Resolve Radio TV Interference Problems*. It is available from the U.S. Government Printing Office, Washington, D.C. 20402, stock number 004 000 00345 4.

The user is cautioned that any changes or modifications not expressly approved by TEAC America, Inc. could void the user's warranty.

---

## Copyright and Trademark Information

Copyright © 2005 TASCAM, a division of TEAC America, Inc. All rights reserved.

TEAC America, Inc. reserves the right to modify product offerings or specifications without advanced notice. No part of this publication may be reproduced in any format without the expressed written permission of TEAC America, Inc.

TASCAM and TEAC are registered trademarks of TEAC Corporation.

All other trademarks and registered trademarks are the property of their respective owners.

---

## Piracy Statement

The copying of audio, video, or software without the permission of the copyright holder is illegal. TEAC accepts no responsibility for copyright infringement or misuse of this equipment. It is the sole responsibility of the user to ensure that the legal copyrights of the copyright owners are respected.

---

## About This Manual

This *TASCAM CD Duplicator User's Manual* explains how to operate the TASCAM CD Duplicator unit. It is divided into the following chapters:

### Chapter 1: Introduction

This chapter describes the shipping package contents and introduces the CD Duplicator unit.

### Chapter 2: Using the CD Duplicator

This chapter explains how to set up the CD Duplicator. It also details its basic copy operation.

### Chapter 3: CD Duplicator Functions

This chapter explains all available functions of the CD Duplicator.

### Appendix A: List of Functions

Appendix A includes a complete list of all CD Duplicator functions.

### Appendix B: LCD Messages

Appendix B lists all messages that may appear on the LCD display.

### Appendix C: About CD-R and CD-RW Discs:

Appendix C contains information about handling, loading, and ejecting discs.

### Appendix D: Specifications

Appendix D includes technical specifications for the TASCAM CD Duplicator unit.

### Appendix E: Technical Support and Warranty

This appendix provides technical support information for TASCAM as well as Limited Warranty information.

---

# Table of Contents

Safety Precautions .....	i
FCC Radio Frequency Interference Regulations .....	i
Copyright and Trademark Information .....	ii
Piracy Statement .....	ii
About This Manual .....	ii
List of Figures .....	v
<b>Chapter 1. Introduction .....</b>	<b>1</b>
CD Duplicator Package Contents .....	2
Front Panel .....	3
Rear Panel .....	5
<b>Chapter 2. Using the CD Duplicator .....</b>	<b>7</b>
Setup .....	7
Basic Operation .....	8
<b>Chapter 3. CD Duplicator Functions .....</b>	<b>9</b>
1 Copy .....	9
2 Test .....	9
3 Test & Copy .....	9
4 Verify .....	10
5 Compare .....	10
6 Prescan .....	10
7 Disc Info .....	10
8 Edit Track .....	10
8.1 CD to CD Edit .....	10
8.2 Play Audio Track .....	10
8.3 Close Session .....	11
9 Setup .....	11
9.1 Language .....	11
9.2 Burn Speed .....	11
9.3 Read Speed .....	11
9.4 Auto Start Drive .....	11
9.5 Startup Menu .....	11
9.6 Auto Verify .....	12
9.7 Auto Compare .....	12
9.8 Auto Prescan .....	12
9.9 Eject Disc .....	12
9.10 Burn Mode .....	12
9.11 Display Time .....	12
9.12 Button Sound .....	13
9.13 Device Info .....	13
9.14 System Info .....	13

9.15 Quick Erase . . . . .	13
9.16 Full Erase . . . . .	13
10 Advanced Setup (Adv Setup) . . . . .	13
10.1 UnderRun Protect . . . . .	13
10.2 Overburn . . . . .	13
10.3 Read Error Skip . . . . .	13
10.4 Burn-in . . . . .	14
10.5 Update Firmware . . . . .	14
10.6 Compare Firmware . . . . .	14
10.7 H/W Diagnostic . . . . .	14
10.8 Load Default . . . . .	14
10.9 CD+G . . . . .	14
10.10 ISRC & MCN . . . . .	14
10.11 Stand Alone and USB Modes . . . . .	15
<b>Appendix A. List of Functions . . . . .</b>	<b>17</b>
<b>Appendix B. LCD Messages . . . . .</b>	<b>18</b>
Normal Conditions . . . . .	18
Audio Editing . . . . .	19
<b>Appendix C. About CD-R and CD-RW Discs . . . . .</b>	<b>20</b>
Handling Discs . . . . .	20
Loading and Ejecting Discs . . . . .	20
<b>Appendix D. Specifications . . . . .</b>	<b>22</b>
<b>Appendix E. Technical Support and Warranty . . . . .</b>	<b>23</b>
Limited Warranty . . . . .	23

---

## List of Figures

Figure 1. CD Duplicator Unit Package Contents .....	2
Figure 2. Front Panel of the CD Duplicator Unit .....	3
Figure 3. LCD Control Panel .....	3
Figure 4. Rear Panel of the CD Duplicator Unit .....	5
Figure 5. Copy Function on LCD Panel .....	7
Figure 6. How to Handle Compact Discs (CD-R and CD-RW) .....	20
Figure 7. Ejecting the Disc Tray .....	21





---

## Chapter 1. Introduction

Thank you for purchasing the TASCAM CD Duplicator unit.

The TASCAM 1x1 CD Duplicator is a stand-alone disc-to-disc CD Duplicator system that does not require connection to a computer.

However, the TASCAM CD Duplicator does feature a USB port that enables you to transfer or record files from your computer to the duplicator's CD-RW (target) drive.

It can duplicate a single master CD to CD-R media at up to 52X speed, resulting in an exact replica of a 700MB disc in just over three minutes. It can also duplicate discs to CD-RW media at up to 32X speed.

The TASCAM 1x1 Duplicator is designed to perform CD copying quickly and accurately.

The CD Duplicator automatically identifies source CD formats and replicates the content as required.

The TASCAM 1x1 CD Duplicator performs continuous copying with no waiting. The TASCAM CD Duplicator is an ideal CD duplicator for the advanced user who requires speed, accuracy, and reliability.

The unit can be set up very quickly. There is no need to attach cables to your computer since the TASCAM CD Duplicator can function entirely as a stand-alone unit if desired.

The CD Duplicator also features a hot-swappable USB (Universal Serial Bus) port, which can be connected to a computer's USB version 2.0 port for data transfer.

The TASCAM CD Duplicator outputs a line-level signal from the left and right RCA phono connectors on the rear panel. These outputs can be connected to the left and right channel inputs on a mixer, amplifier, or powered speakers.

## CD Duplicator Package Contents

Your TASCAM CD Duplicator package includes the following items (see Figure 1).

- TASCAM CD Duplicator unit
- AC power cable
- TASCAM CD Duplicator User's Manual* (this booklet)

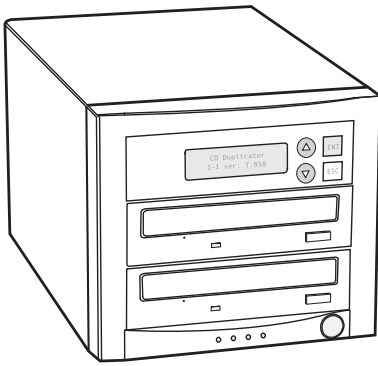

*TASCAM CD Duplicator unit*

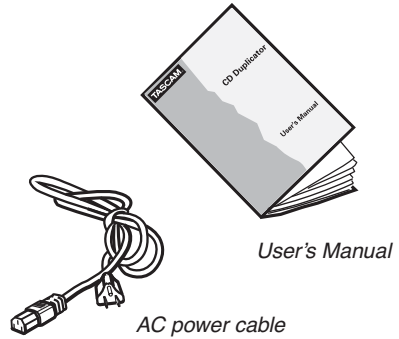

*User's Manual*

*AC power cable*

*Figure 1. CD Duplicator Unit Package Contents*

**Note:** *If any of the items above is missing from your package upon purchase, please contact your vendor immediately.*

## Front Panel

Figure 2 illustrates the front panel of the CD Duplicator unit.

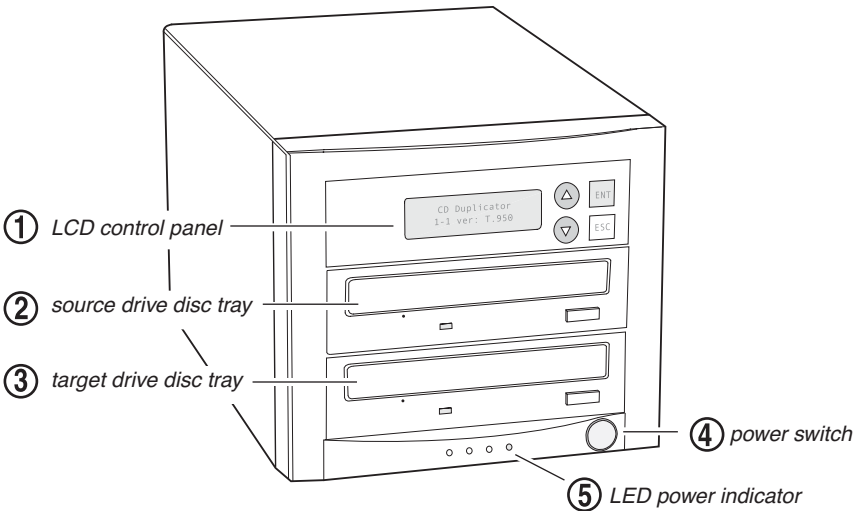

Figure 2. Front Panel of the CD Duplicator Unit

- ① **LCD control panel:** Use the control panel buttons to navigate through the various functions viewed on the LCD display.

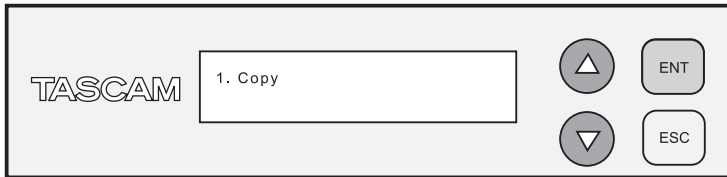





Figure 3. LCD Control Panel

The CD Duplicator control panel features an LCD display and four buttons. These buttons are described in the following table:

	Press the Up arrow button to scroll up functions or menus.
	Press the Down arrow button to scroll down functions or menus.
	Press the ENT (Enter) button to execute a selected function.
	Press the ESC (Escape) button to cancel a selected function or go back to the main menu.

- ② **source drive disc tray:** Insert the disc to be copied into the source drive. Use the disc tray to load CDs into the drive. You can open the tray by pressing the eject button (if the tray fails to open, you can use the emergency eject mechanism). You can close the tray by pressing the eject button.

*Note: TASCAM strongly recommends that you do not push the tray in to close it. Please press the eject button to eject or retract the tray.*

- ③ **target drive disc tray:** Insert a blank disc into the target drive to make a copy of the source disc. You can open the tray by pressing the eject button (if the tray fails to open, you can use the emergency eject mechanism). You can close the tray by pressing the eject button.

*Note: TASCAM strongly recommends that you do not push the tray in to close it. Please press the eject button to eject or retract the tray.*

- ④ **power switch:** Use the power switch to turn the power to the CD Duplicator unit on and off.
- ⑤ **LED power indicator:** The LED power indicator will be continuously lit when the CD Duplicator power is on.

## Rear Panel

Figure 4 illustrates the rear panel of the CD Duplicator unit.

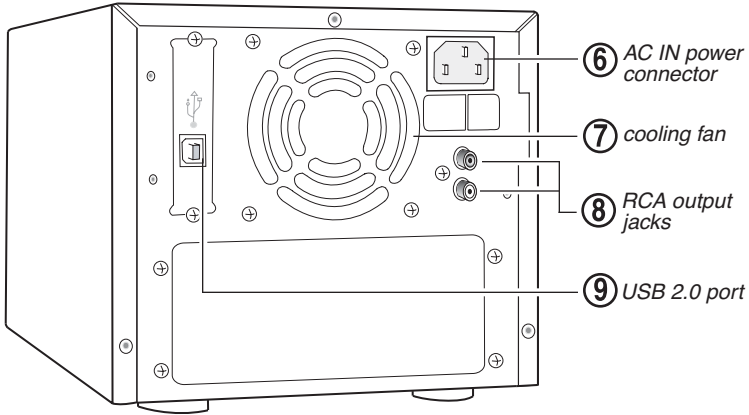

Figure 4. Rear Panel of the CD Duplicator Unit

- ⑥ **AC IN power connector:** Connect the included AC power cable to this input connector. Plug the other end of the power cable into a three-prong receptacle AC power outlet.

**Caution:** Do not attempt to bypass the grounding plug. Otherwise, you risk damage to the unit and electrical shock.

**Note:** To ensure proper operation, use only the original AC power cable with your TASCAM CD Duplicator unit.

- ⑦ **cooling fan:** Ball-bearing fan cools the CD Duplicator.
- ⑧ **RCA output jacks:** Connect RCA phono plugs to these left and right stereo output jacks. (The left channel is white; the right channel is red.) Connect the other ends of the phono cables to an amplifier, powered speakers, or a computer soundcard. A stereo audio signal will be output from the source drive.
- ⑨ **USB 2.0 port:** Connect an optional USB interface cable from this USB connector to a USB 2.0 port on your computer. The CD Duplicator will appear on your computer and function as an external CD-RW drive.

For more information, see Chapter 3, Function 10.11 “Stand Alone and USB Modes” on page 15.



---

## Chapter 2. Using the CD Duplicator

This chapter explains the set up of the CD Duplicator, as well as basic operation and menu function.

---

### Setup

1. Carefully remove the CD Duplicator unit, AC power cord and user's manual from the shipping box.

*Note: Please keep the original box and packaging materials in case of future storage or transportation.*

2. Locate the CD Duplicator unit on a stable, flat surface.
3. Connect one end of the included power cable to the back of the CD Duplicator. Connect the other end of the power cable to a three-prong receptacle AC outlet.

*Caution: Do not attempt to bypass the grounding plug. Otherwise, you risk damage to the unit and electrical shock.*

4. Turn on the power to the CD Duplicator by pressing the power button on the lower right-hand side of the unit.

During initialization, the CD Duplicator performs a self-test in which the unit's internal buffer is tested, source and target drives are detected, and the LCD display is tested. Once the initialization is complete, the CD Duplicator is ready for use.

The LCD displays the Copy function by default.

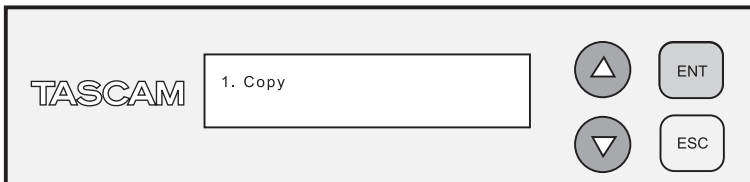



Figure 5. Copy Function on LCD Panel

## Basic Operation

### Stand Alone Mode

This section explains the basic operation of the CD Duplicator.

1. **Place your source disc in the disc tray of the top drive (source drive).**
2. **Switch to function [1 Copy] by pressing the  button.**
3. **Place a blank CD-R disc into the bottom drive (target drive), and press the ENT button to start copying.**
4. **When the copy operation is complete, the CD-R disc in the target drive will be ejected automatically.**

***Note:** With the default setting, after a source disc has been successfully copied, the CD Duplicator automatically ejects the target CD-R disc.*

*With the default setting, if the copy operation fails, the failed target CD-R disc remains in the target drive. To remove the failed CD-R disc, press the eject button on the bottom drive (target drive) and retrieve the disc. Press the eject button again to retract the disc tray. You can change the default settings by using the Advanced Setup menu.*

### USB Mode

For USB Mode, reference Chapter 3, Function 10.11 “Stand Alone and USB Modes” on page 15.



---

## Chapter 3. CD Duplicator Functions

The CD Duplicator features 10 functions: Copy, Test, Test & Copy, Verify, Compare, Prescan, Disc Info, Edit Track, Setup, and Advanced Setup. Each function is explained below.

---

### 1 Copy

1. **To copy a disc, insert the source disc in the top drive (source drive) and a blank disc in the bottom drive (target drive).**
2. **Press the ENT button.**

The target drive ejects the copied disc after the copy process is complete.

3. **For an additional copy of the same source disc, insert another blank CD-R disc in the target drive and press the ENT button.**

Otherwise, press ESC to return to the main menu.

*Note: You can use CD-RW discs that already contain data (i.e., CD-RW discs that are not fully blank) as target discs. However, the data stored on the CD-RW disc will be erased automatically before the new data is copied. No special setting or procedure is required to erase the old data.*

---

### 2 Test

This function simulates writing to the target disc. Discs remain blank after the test is complete. This function is recommended if you are using non-supported media. This function enables the target drive to emulate and adjust its laser to a proper intensity.

*Note: Unexpected termination or cancellation of a test will not affect a target CD-R disc. The target CD-R disc will remain blank and available for use. However, CD-RW discs that contain data may be damaged and the data they contained may be rendered unrecoverable. It may be necessary to re-start the CD Duplicator if the target drive hangs during a sudden termination.*

---

### 3 Test & Copy

This function performs the test simulation and the copy process in one step.

The copy process is performed only if the simulation detects no problems. If the simulation fails, the copy process is cancelled.

## 4 Verify

This function verifies that the target disc was written completely and with no errors.

---

## 5 Compare

The data between source and target discs is compared after the copy process is complete.

*Note: This function works only with data discs.*

---

## 6 Prescan

This function is performed in the source drive. It scans the disc to determine the maximum data/audio extraction speed.

---

## 7 Disc Info

This function displays complete information about the source disc, including sessions, tracks, capacity, etc.

---

## 8 Edit Track

Edit Track is designed exclusively for editing a collection of favorite songs from different audio discs.

*Note: The CD+G value must be set to OFF in order to use the Track Extraction feature. For more information, refer to “10 Advanced Setup (Adv Setup)” on page 13.*

---

### 8.1 CD to CD Edit



This function enables you to select specific tracks from various audio discs and combine them to create a collection of favorite songs on a single disc.

*Note: CD-R discs support up to 80 minutes of audio. Therefore, the number of tracks that can be copied into a single disc depends on the length of each individual track.*

---

### 8.2 Play Audio Track

This function enables the source drive to function as a music player. If you connect standard multimedia speakers to the RCA audio jacks on the rear panel of

the CD Duplicator, then select **Play Audio Track**. You will now hear the audio program from the source drive. The arrow buttons   in the LCD panel enable you to skip to the next track forward or back.

---

## 8.3 Close Session

This function finalizes your CD-R disc. Once a CD-R disc is finalized, no more audio can be added to that disc.

---

## 9 Setup

The Setup menu contains a list of options that enable you to change the original default configuration. There are various settings available under the Setup menu that control the operation of the CD Duplicator. However, TASCAM recommends that you use the original default settings for optimal operation.

---

### 9.1 Language

The CD Duplicator LCD panel can display text in English and Spanish.

English is the default option.

---

### 9.2 Burn Speed

This setting controls the writing speed of the target drive. The default setting is **MAXIMUM**, which uses the highest writing speed of the target drive. On occasion, using the maximum writing speed will cause copy failure due to poor quality CD-R discs or unstable CD writing at high speed. In this case, TASCAM recommends that you lower the writing speed.

---

### 9.3 Read Speed

This function will set the reading speed of the target drive. **MAXIMUM** is the default setting.

---

### 9.4 Auto Start Drive

This setting enables the CD Duplicator to auto-start the copy or test process as soon as a blank disc is inserted into the target drive. The default setting is **OFF**.

---

### 9.5 Startup Menu

This setting selects one of the menu items to be displayed as the first menu item when you turn on the CD Duplicator. **COPY** is the default menu item selected.

### 9.6 Auto Verify

This setting controls auto verification of discs after a copy process. The default setting is OFF.

---

### 9.7 Auto Compare

This setting controls auto-comparison of data between source and target discs after a copy process. The default setting is OFF.

---

### 9.8 Auto Prescan

This setting controls automatic prescan in the source disc whenever a data/audio disc is inserted in the source drive. The default setting is OFF.

---

### 9.9 Eject Disc

This setting controls the ejection of discs by the target drive. Three options are available:

- Eject Good Only This option ejects only successfully copied discs. This is the default setting
  - Eject All Disc This option ejects successful and failed copied discs
  - Do Not Eject With this option, all discs remain in the target drive. Manual ejection is required after every copy process.
- 

### 9.10 Burn Mode

This setting controls three writing methods:

- Disc At Once (DAO)
- Track At Once (TAO)
- TAO Not Close

DAO is the default setting.

---

### 9.11 Display Time

This function displays the total time of each copy process. The default setting is OFF.

### **9.12 Button Sound**

This setting turns the button sound On or Off. The default setting is ON.

---

### **9.13 Device Info**

This function displays information for both the source and target drive.

---

### **9.14 System Info**

This function displays information for the interface board.

---

### **9.15 Quick Erase**

This function performs a Quick erase on CD-RW discs.

---

### **9.16 Full Erase**

This function performs a Full erase on CD-RW discs. This function takes longer than the Quick erase.

---

## **10 Advanced Setup (Adv Setup)**

Some Advanced Setup functions enable you to change the system configuration. You should make changes only after you become completely familiar with the functions in this menu. To enter the Advanced Setup, press the ESC button for two (2) seconds.

---

### **10.1 UnderRun Protect**

This setting turns Buffer UnderRun Protection ON or OFF. The default setting is ON.

---

### **10.2 Overburn**

This setting turns the Overburn function in the target drive ON or OFF. The default setting is OFF.

---

### **10.3 Read Error Skip**

This setting controls error skipping during reading of the source disc. When an error is detected, the target drive stops and displays the read error message. If the setting is ON, no messages will be displayed if an error occurs. The copy process will be completed and will include all errors found in the process. The default setting is OFF.

---

---

## 10.4 Burn-in

This function runs an emulate writer function continuously. The disc in the target drive is ejected and re-inserted automatically between each cycle test. This function can be prepared to run continuously, or specified to run from 1 to 1000 times.

---

## 10.5 Update Firmware

This function updates the firmware of the interface board via CD disc. The disc must contain the required data file and be inserted in the source drive. The CD Duplicator finds the data and updates its firmware automatically. During the update, do not turn off the power to the machine. The update process is complete after the system resets automatically and displays the main menu.

---

## 10.6 Compare Firmware

This function compares the current firmware version in the interface board to the update version in the disc.

---

## 10.7 H/W Diagnostic

This function detects the devices connected to the interface board and checks for functionality. The LCD displays information on the hardware.

---

## 10.8 Load Default

This function resets all factory default settings. It is recommend that you reset the defaults if the CD Duplicator fails to function properly after you made changes to the original configuration.

---

## 10.9 CD+G

This function enables or disables CD+G (karaoke CD) format support. The default setting is OFF.

*Note: The CD+G value must be set to OFF in order to use the Track Extraction features.*

---

## 10.10 ISRC & MCN

This function enables or disables ISRC and MCN format support. The default setting is ON.

## 10.11 Stand Alone and USB Modes

This function enables or disables the USB port on the CD Duplicator. The default mode is Stand Alone.

*Note: The minimum system requirements for your computer to work with this duplicator in USB Mode:*

### **PC**

- IBM-Compatible PC Pentium 800MHz or higher
- 128MB RAM
- Windows 2000 or XP
- One available USB 2.0 port.

### **Macintosh**

- G4 System or higher
- Mac OS 10.0

To switch to USB mode, follow these steps:

### **1. Turn the unit on.**

The LCD panel will read 1. Copy.

### **2. Enter the Advance Setup (Adv Setup) menu by pressing the ESC button for two seconds.**

### **3. In the Adv Setup menu, press the down arrow button repeatedly until the LCD panel displays Switch USB Mode, then press the ENTER button.**

The LCD displays USB L.H. Mode.

### **4. Connect the “B” side plug of an optional USB cable to the back of the CD Duplicator.**

### **5. Connect the other end of the USB cable to a USB 2.0 port on your computer.**

Only the target (bottom) drive of the CD Duplicator will be recognized by the computer as an external USB device.

On a Windows computer, the CD Duplicator drive will be assigned the next available drive letter in “My Computer” and in Windows Explorer.

On a Macintosh computer, an icon titled “XXXXXXXX” will appear on the computer desktop.

*Note: If you have recording software installed on your computer, you will be able to record files from the computer to the CD Duplicator's target drive.*

**6. To switch back to Stand Alone mode:**

- Windows* users should disable the USB port using the icon on the Task Bar and then disconnect the USB cable from the computer and the CD Duplicator unit.
- Mac* users should drag the CD Duplicator's icon into the Trash, then disconnect the USB cable from the computer.

**7. Press the up arrow  button.**

The LCD panel displays Back to SA Mode? Yes.

**8. Press the ENT button.**

The CD Duplicator unit will reinitialize, and the LCD panel will read 1. Copy.



---

## Appendix A. List of Functions

- 1 Copy
- 2 Test
- 3 Test & Copy
- 4 Verify
- 5 Compare
- 6 Prescan
- 7 Disc Info
- 8 Edit Track (for CD only)
  - 8.1 CD to CD
  - 8.2 Play Audio Track
  - 8.3 Close Session
- 9 Setup
  - 9.1 Language (English)
  - 9.2 CD Burn Speed (Default is Auto)
  - 9.3 Read Speed (Default is Maximum)
  - 9.4 Auto Start Drive (Default is Off)
  - 9.5 Startup Menu (Default is Copy)
  - 9.6 Auto Verify (Default is Off)
  - 9.7 Auto Compare (Default is Off)
  - 9.8 Auto Prescan (Default is Off)
  - 9.9 Eject Disc (Default is Eject Good Only)
  - 9.10 Burn Mode (Default is DAO)
  - 9.11 Display Time (Default is Off)
  - 9.12 Button Sound (Default is On)
  - 9.13 Device Info
  - 9.14 System Info
  - 9.15 Quick Erase
  - 9.16 Full Erase
- 10 Advanced Setup (Adv Setup)
  - 10.1 UnderRun Protect (Default is On)
  - 10.2 Overburn (Default is Off)
  - 10.3 Read Error Skip (Default is Off)
  - 10.4 Burn in
  - 10.5 Update Firmware
  - 10.6 Compare Firmware
  - 10.7 H/W Diagnostic
  - 10.8 Load Default
  - 10.9 CD+G (Default is Off)
  - 10.10 ISRC & MCN (Default is On)
  - 10.11 Stand Alone and USB Modes

---

## Appendix B. LCD Messages

---

### Normal Conditions

---

Message	Meaning
Initialize SDRAM	Initialize the memory of the system.
Detect Drives	Detect drives are connected to the system.
User Abort!	Cancel a job during operation.
Analyzing	Analyze the source disc.
Source Drive Not Ready	Source drive is not ready to read.
Target Drive Not Ready	Target drive is not ready to write.
Source Disc Not Ready	Source disc is not ready to be read.
Target Disc Not Ready	Target disc is not ready to be written to.
Erasing disc	The system is erasing the data on the disc.
Fail to get Drive Info!	The drive information cannot be obtained.
Fail to get Src Disc Info!	The information of the source disc cannot be obtained.
Save new config Fail!	The new configuration setting cannot be saved.
Load Default Config?	Do you want to load the default settings?
Src&Tgt can't in the same channel	During comparison, the source and target discs cannot be in the same channel.
Preparing	The system is preparing to record.
Check Target Please Wait	The system is checking the target device.
Audio Disc!!! Can't compare!	The system cannot compare audio discs.
Identical	The comparison results are the same.
Read disc error	During comparison, the disc cannot be read.
Cannot read TOC	The system cannot read the contents of the disc.
TOC not match	The comparison results are not the same.
Source Disc Empty!!!	The source disc does not contain any data.
Target overflow	The target disc does not have enough capacity to store the new data.
Target Disc Not Empty!!!	The target disc still contains data.
Press a Key to Eject Good Disc	Press any key to eject a good disc after copying.
Press a Key to Eject Fail Disc	Press any key to eject a failed disc after copying.
CD-RW does not Support the Func	CD-RW doesn't support this function.
Hold ESC to exit	Press ESC for one second to terminate the test.
All data will be lost, erase?	All data on the disc will be lost. Confirm erasure of data.
Erase Finished	The erasing of data is complete.
No Eraseable Disc in CD-RW!!	The disc on the CD-RW device is not rewritable.

---

## Audio Editing

Message	Meaning
Lost selected Tracks?	Abort the selected tracks and delete them.
End edit disc and burn?	Finish the music disc editing and start to copy.
Continue edit next Disc?	Ask if you want to continue the music disc editing.
Target Overflow Re-Select	The disc capacity is insufficient to store the selected tracks. Please select again.
Close all disc's session?	Confirm the closing of disc sessions.
NO AUDIO track in this disc	The source disc has no audio track.
Insert next disc	Insert the next audio disc.
Sessions were closed already!	The disc sessions have already been closed.
Tgt overflow, del last trk?	The disc capacity is insufficient to store the selected tracks. Do you want to delete the last track?
Ins empty disc Continue?	Do you want to insert a blank disc and continue copying?

---

## Appendix C. About CD-R and CD-RW Discs

This appendix explains how to handle, load, and eject CD-R and CD-RW discs.

---

### Handling Discs

- ❑ Handle compact discs only by their edges to avoid getting fingerprints on the surface. Do not touch the disc's data surface (unlabeled side).
- ❑ Do not place discs in direct sunlight, or in locations subject to high humidity, high temperatures, or dusty conditions.
- ❑ If cleaning the disc becomes necessary (erratic operation or visible dust or smudges), gently wipe the surface of the disc from the center to the outside edge. Do not use benzene, alcohol, thinner, or other solvents.

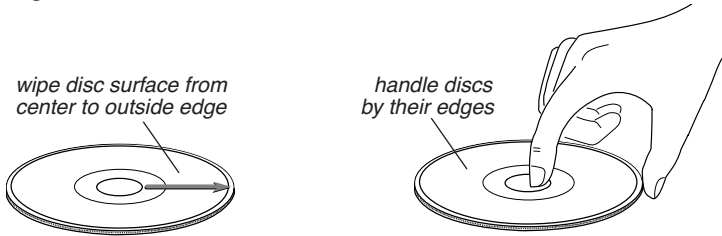

Figure 6. How to Handle Compact Discs (CD R and CD RW)

---

### Loading and Ejecting Discs

To load a disc into the source or target drive, first open the disc tray by pressing the Eject button on the front of the drive. Place the disc on the disc tray with its label side facing up. Then press the Eject button again to retract the disc tray back into the drive.

To eject a disc from source or target drive, press the Eject button on the front of the drive to extend the disc tray. Remove the disc from the disc tray and place it in its protective case. Then press the Eject button again to retract the disc tray back into the drive.

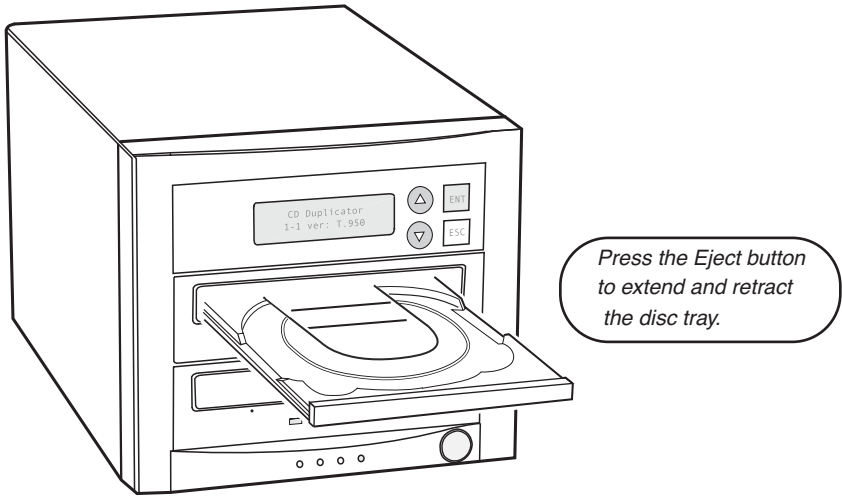

Figure 7. Ejecting the Disc Tray

## Appendix D. Specifications

The following table lists the product specifications for the TASCAM CD Duplicator.

Model	CD-D11U
CD Recorder	TEAC 52x32x52 CD-RW
Drive Interface	IDE / ATAPI
Read Speed	52x
Write Speed	CD-R: 52x CD-RW: 32x
Drive Buffer Size	2MB
System Buffer Size	8MB
Supported Discs	CD-R, CD-RW (12 & 8cm), card discs
Supported Formats	CD-ROM Mode 1 & 2; CD-DA; CD-ROM/XA Video CD, Game CD Mix Mode, Multi-session, HFS CD Bridge, Photo CD; CD Extra, CD+G (Karaoke), CD-R, CD-RW
System Control	Copy and Search Buttons
System Display	LCD Panel; LED Indicator
Write Method	Auto Detect (DAO, TAO)
Operation Mode	Copy, Test, Scan, Compare
Firmware Upgrade	Via CD-ROM
Dimension	6.7 x 7.5 x 11.2 (H x W x D) Inches
Weight	11.65 lbs.
Power Supply	AC Input: 100~240V
Agency Certification	FCC, UL  <i>Note: If you plan to use the TASCAM CD Duplicator with a computer, connect the CD Duplicator to only UL Listed IBM PC (or compatible) or Macintosh computers that feature a USB (Universal Serial Bus) port, version 2.0.</i>

---

## Appendix E. Technical Support and Warranty

For technical support on your TASCAM CD Duplicator, please contact the TASCAM Support Center.

TASCAM  
Technical Support  
(323) 727 7617  
Monday through Friday, 8 am to 5 pm Pacific Time  
E mail: tascamrepair@teac.com

---

### Limited Warranty

This product is warranted by TEAC America, Inc. against defects in materials and workmanship. **LENGTH OF WARRANTY** This warranty will be effective for both labor and parts, and this warranty will be effective for one (1) year from the date of original purchase.

**WHO MAY ENFORCE THE WARRANTY** This warranty is valid only in the United States, and enforceable only by the original purchaser. This warranty is not valid outside the United States.

**WHAT IS NOT COVERED BY THIS WARRANTY**

1. Damage to or deterioration of the external cabinet.
2. Damage resulting from accident, misuse, abuse, or neglect.
3. Damage resulting from failure to follow instructions contained in your user's manual.
4. Damage occurring during shipment of the product (claims must be presented to the carrier).
5. Damage resulting from repair or attempted repair by anyone other than TEAC Service Department.
6. Damage resulting from modification or attempted modification of product not authorized by TEAC.
7. Damage resulting from causes other than product defects, including lack of technical skill, competence, or experience of the user.
8. Damage to any unit that has been altered or on which the serial number has been defaced, modified or removed.
9. Damage or malfunction resulting from installation and cabling.
10. For wireless configurations, TEAC cannot be responsible for interference or operation in locations that restrict range.
11. Damage to or from interconnected network equipment.
12. Data integrity or loss of data.

**HOW YOU CAN GET WARRANTY SERVICE** – Please contact the TASCAM service department for a Return Authorization number before shipping unit(s) to TASCAM. Information required for R/A request should include your name and/or company name, telephone number, TASCAM model, version and serial number(s). Return Authorization (R/A) number must be clearly marked on the outside of each carton shipped to TASCAM. Return merchandise must be packed in original shipping containers or otherwise packed adequately to prevent damage in shipment. You are responsible for all risk of damage to or loss of merchandise in transit to TASCAM. TASCAM reserves the right to reject any merchandise that is not packaged and/or marked as instructed herein. You must pay any shipping charges if it is necessary to ship the product for service. However, if the necessary repairs are covered by the warranty, we will pay the return shipping charges to any destination within the United States. Whenever warranty service is required, you must present a copy of the original dated sales receipt as proof of warranty coverage. Please contact us at the addresses listed at the end of this warranty statement.

**WHAT TASCAM WILL PAY FOR** – We will pay all labor and material expenses for items covered by the warranty. Payment of shipping charges is discussed in the next section of this warranty.

### LIMITATION OF IMPLIED WARRANTIES

ANY IMPLIED WARRANTIES, INCLUDING WARRANTIES OF MERCHANTABILITY AND FITNESS FOR A PARTICULAR PURPOSE, ARE LIMITED IN DURATION TO THE LENGTH OF THIS WARRANTY.

**EXCLUSION OF DAMAGES**

TASCAM'S LIABILITY FOR ANY DEFECTIVE PRODUCT IS LIMITED TO REPAIR OR REPLACEMENT OF THE PRODUCT, AT TEAC'S OPTION. TASCAM SHALL NOT BE LIABLE FOR DAMAGES BASED UPON INCONVENIENCE, LOSS OF USE OF THE PRODUCT, LOSS OF TIME, INTERRUPTED OPERATION OR COMMERCIAL LOSS, LOST PROFITS OR ANY OTHER DAMAGES, WHETHER INCIDENTAL, CONSEQUENTIAL, PUNITIVE OR OTHERWISE.

SOME STATES DO NOT ALLOW LIMITATIONS ON HOW LONG AN IMPLIED WARRANTY LASTS AND/ OR DO NOT ALLOW THE EXCLUSION OR LIMITATION OF INCIDENTAL OR CONSEQUENTIAL DAMAGES, SO THE ABOVE LIMITATIONS AND EXCLUSIONS MAY NOT APPLY TO YOU.

THIS WARRANTY GIVES YOU SPECIFIC RIGHTS, AND MAY VARY FROM SOME OF THE RIGHTS PROVIDED BY LAW. THESE RIGHTS MAY VARY FROM STATE TO STATE.

To contact the TASCAM Service Center in the United States:

(323) 727-7617

Monday through Friday, 8 am to 5 pm Pacific Time

E-mail: [tascamrepair@teac.com](mailto:tascamrepair@teac.com)

TASCAM

7733 Telegraph Road

Montebello, California 90640